



Water Free & Chemical Free Dyeing Introducing the Green Revolution In collaboration with Bianco

Data 22-9-2017

Kasper Nossent
DyeCoo





Water Free & Chemical Free Dyeing
Introducing the Green Revolution
In collaboration with Bianco

DyeCoo[®]

Kasper Nossent
Managing Director DyeCoo Asia

- › A unique CO₂-dyeing technology offering a water-free and chemical-free solution for synthetic fibres
- › Successfully commercialised its technology with the potential to develop a sustainable position in the global textile industry
- › Support of leading brands such as ADIDAS (DryDye) & NIKE (Colordry)
- › Collaboration with state of the art machine builders like Bianco
- › Customers in sportswear, outdoor, retail, upholstery & automotive

WE HAVE REACHED THE COMMERCIAL TIPPING POINT

- › Increasing pressure on sustainability from brands and legislation
- › Proven equal or lower cost to jet dyeing (polyester)
- › Latest version the DyeOx4.0 was launched in December 2016
- › Commissioning of 2 DyeOx4.0 machines in February 2017 in Taiwan
- › 2nd Machine sold to Far Eastern Textiles (June 2017)
- › 3 Machines sold in Vietnam to CleanDye (Sept 2017)

STRATEGY TOWARDS SUCCESS..

- › Customers are the technology ambassadors
- › Collaboration is key ... partnerships essential

EVOLUTION TO INDUSTRIAL SUCCESS

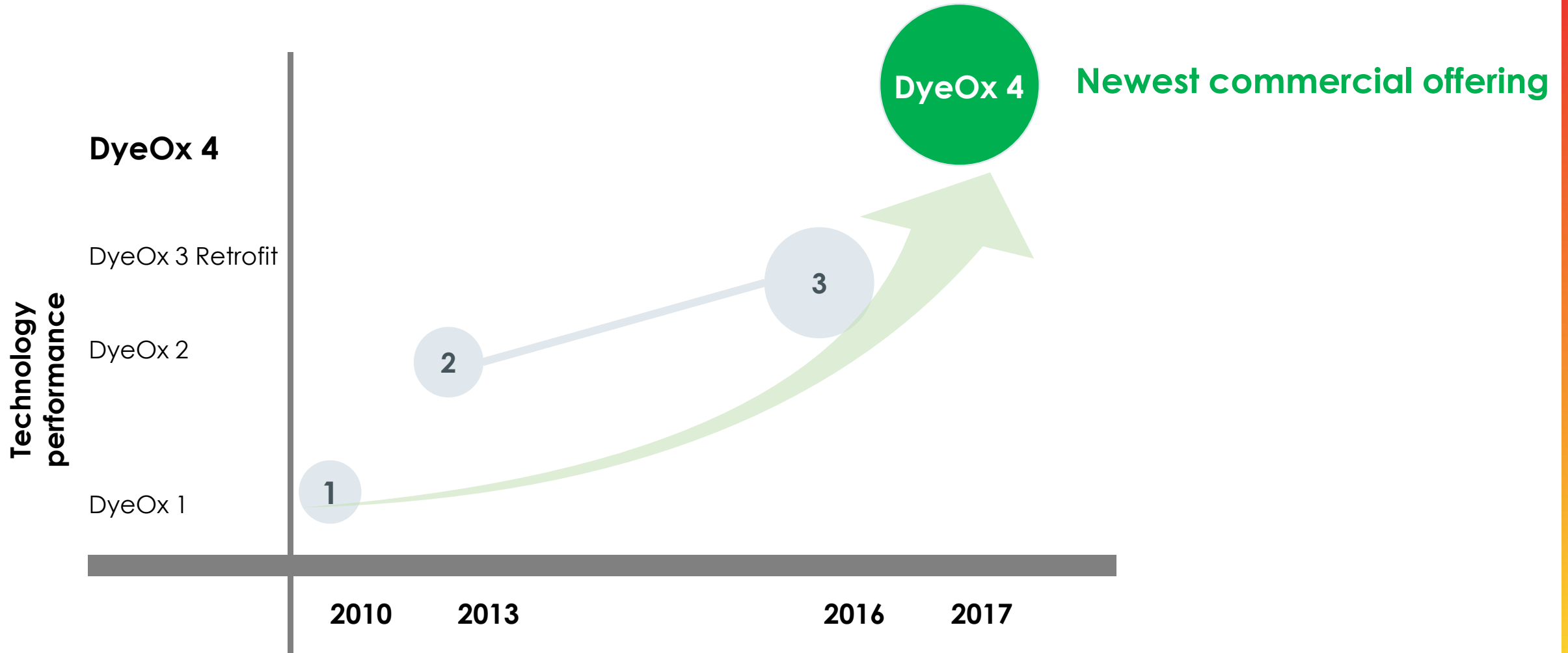

DYECOO'S CURRENT MACHINE COUNT...



3 Machines
Thailand



2 Machines
Taiwan



2 Machines
Taiwan



1 Machine
Taiwan



FORMOSA TAFFETA CO., LTD.

1 Machine
Taiwan



CleanDye
3 Machines
Vietnam

Introducing the green revolution

Kasper Nossent – Managing Director DyeCoo Asia

1 BILLION PEOPLE DO NOT HAVE ACCESS TO CLEAN WATER



WATER STRESS BY COUNTRY

ratio of withdrawals to supply

- Low stress (< 10%)
- Low to medium stress (10-20%)
- Medium to high stress (20-40%)
- High stress (40-80%)
- Extremely high stress (> 80%)

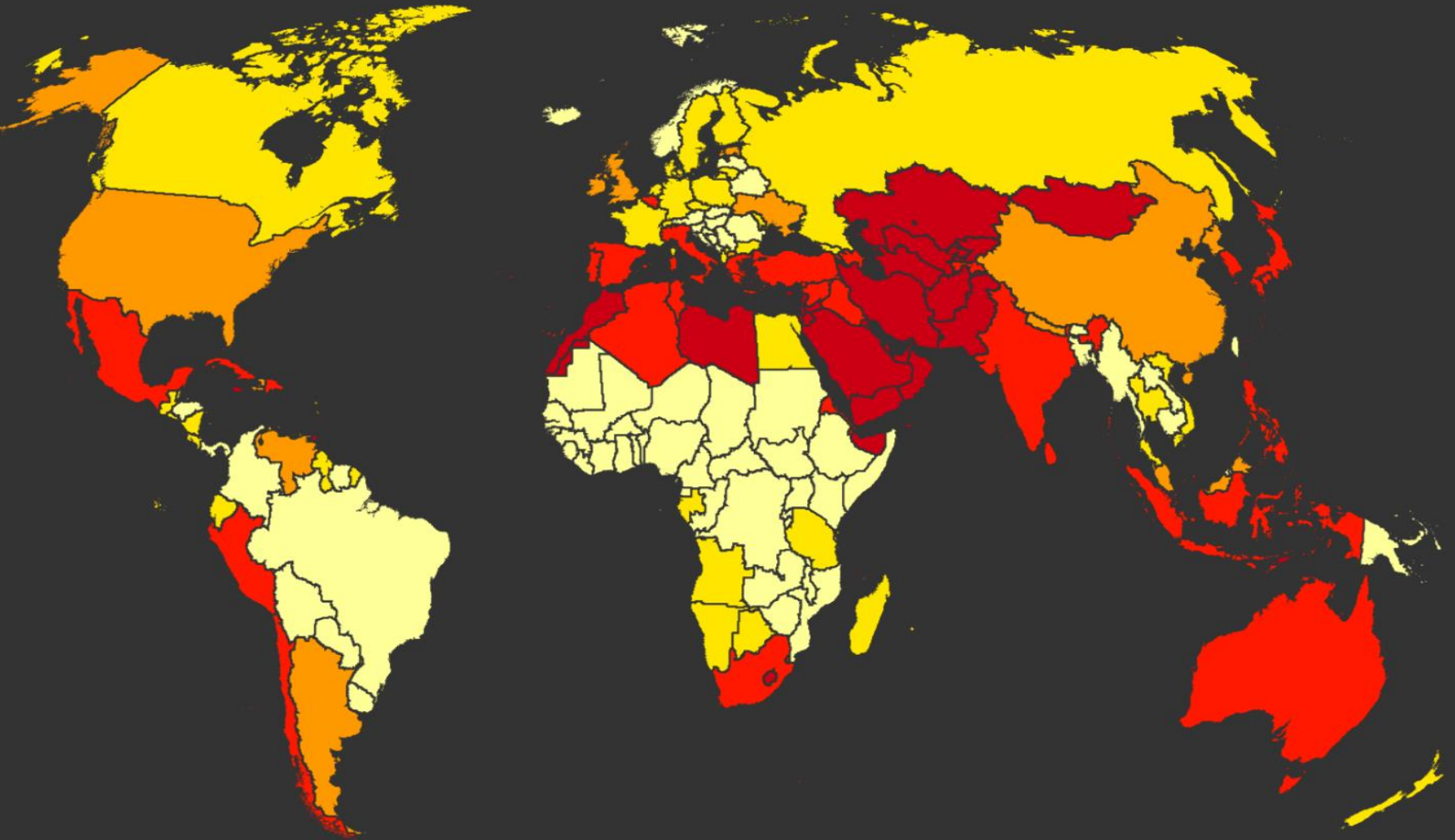

THE WORLD DEMANDS MORE SUSTAINABLE OPTIONS



The world's first water-free and process
Chemical-free textile dyeing solution

ENVIRONMENTAL BENEFITS OF USING DYECOO CO₂ TECHNOLOGY



The infographic features a central white circle containing the text "ZERO WATER". Below this central circle are five smaller white circles, each containing a different benefit. The circles are arranged in a horizontal line. The background is a vibrant yellow with a large, flowing, magenta fabric-like shape that curves around the central and bottom circles. The overall design is clean and modern.

ZERO
WATER

NO PROCESS
CHEMICALS

NO
WASTE
WATER

ENERGY
EFFICIENT

QUICK
PROCESS

LESS DYES

ANNUAL SAVINGS

- > **Water.** 15 – 27 Olympic swimming pools
- > **Chemical.** 6 fully loaded 40ft feet containers
- > **Energy.** CO₂ dyeing consumes less energy



THE SUSTAINABLE PROPOSITION FOR YOUR BUSINESS...



THE PUSH FROM LEGISLATION & SOCIETY



THE PULL FROM BRANDS



CO2 DYING HAS LOWER OPERATIONAL COSTS THAN WATER DYEING...

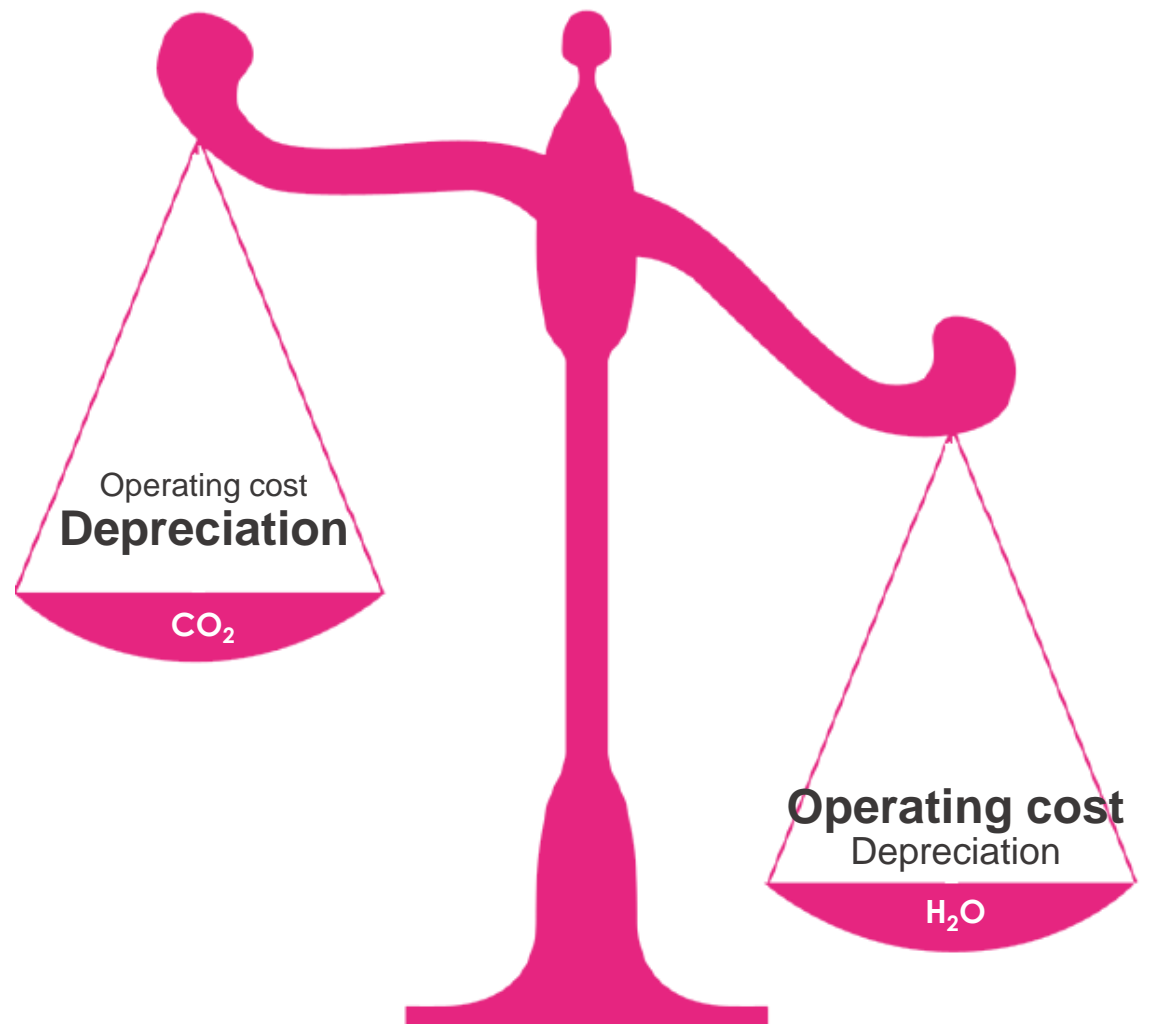

SIGNIFICANT SAVINGS IN OPERATIONAL COST FOR CO₂ DYEING



-68%

Less dyestuff &
chemical cost

-34%

Less energy cost

-36%

Less variable cost

-9%

Less total operational cost

- Including depreciation
- Overhead

\$0

Water intake cost

\$0

Wastewater cost

A game changing technology

KASPER NOSSENT – MANAGING DIRECTOR DYECOO ASIA

“We can’t solve problems
by using the same kind of
thinking we used when we
created them”

ALBERT EINSTEIN

WHAT IS SUPERCRITICAL CO₂

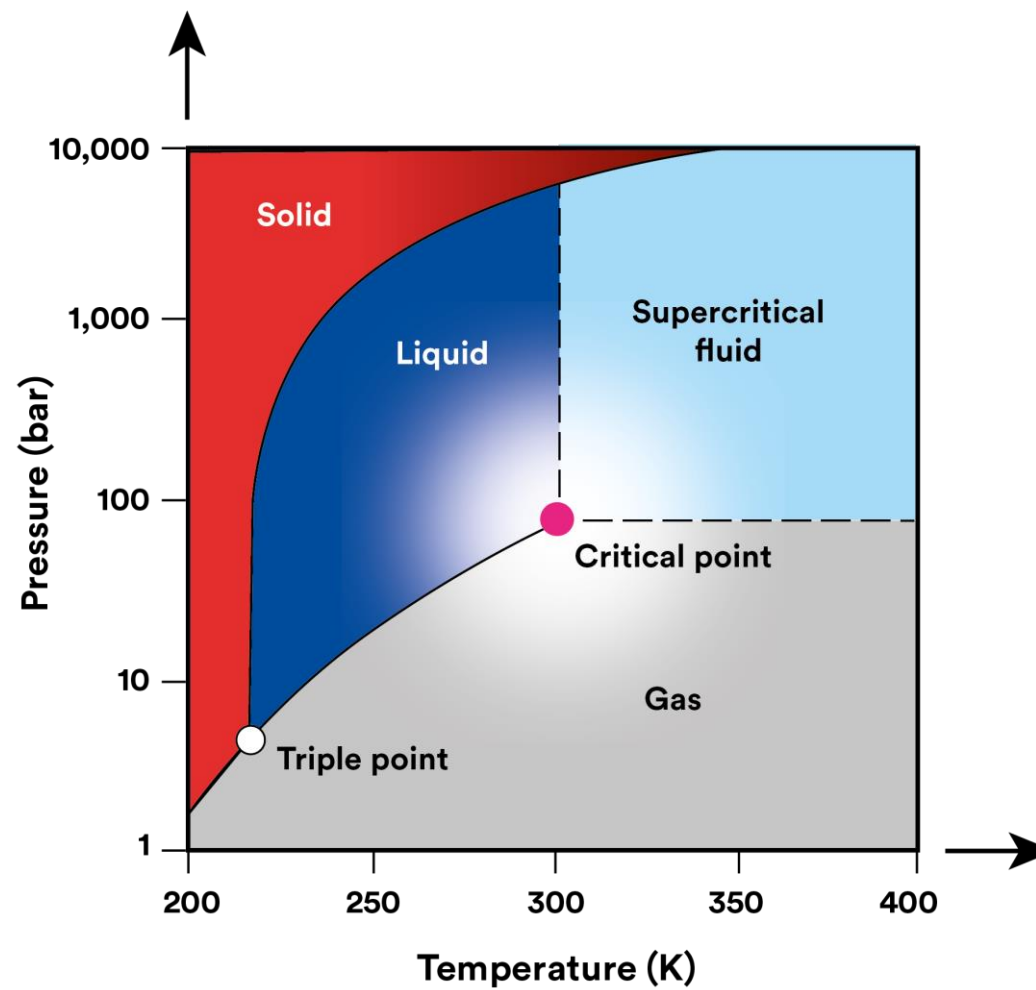

CO2 DYEING EXPLAINED IN A NUTSHELL

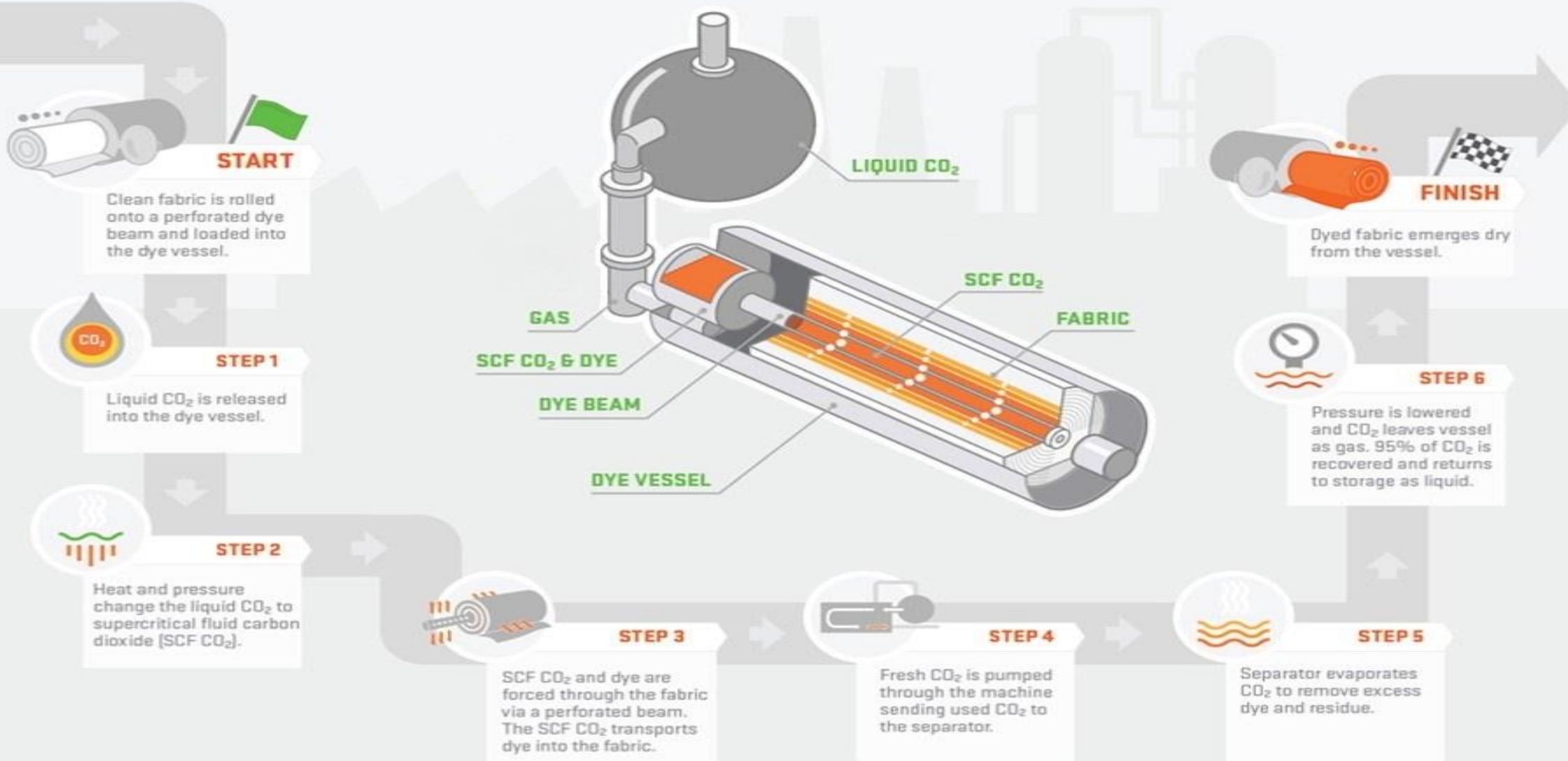

LEADING THROUGH INNOVATION:
ZERO DISCHARGE AS AN OBJECTIVE FOR DYEING AND FINISHING...



Polyester



Fiber bulk

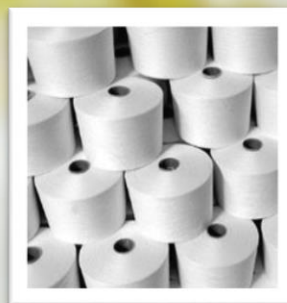

Yarn



Fabrics

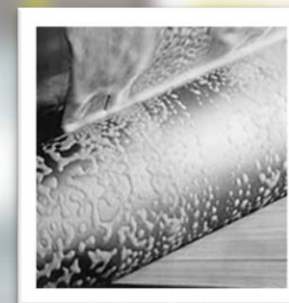

Pre-treatment



Dyeing



Post-treatment

In the future also scouring and finishing in CO₂
Not one drop of water used Zero Discharge!

FROM ART TO SCIENCE...

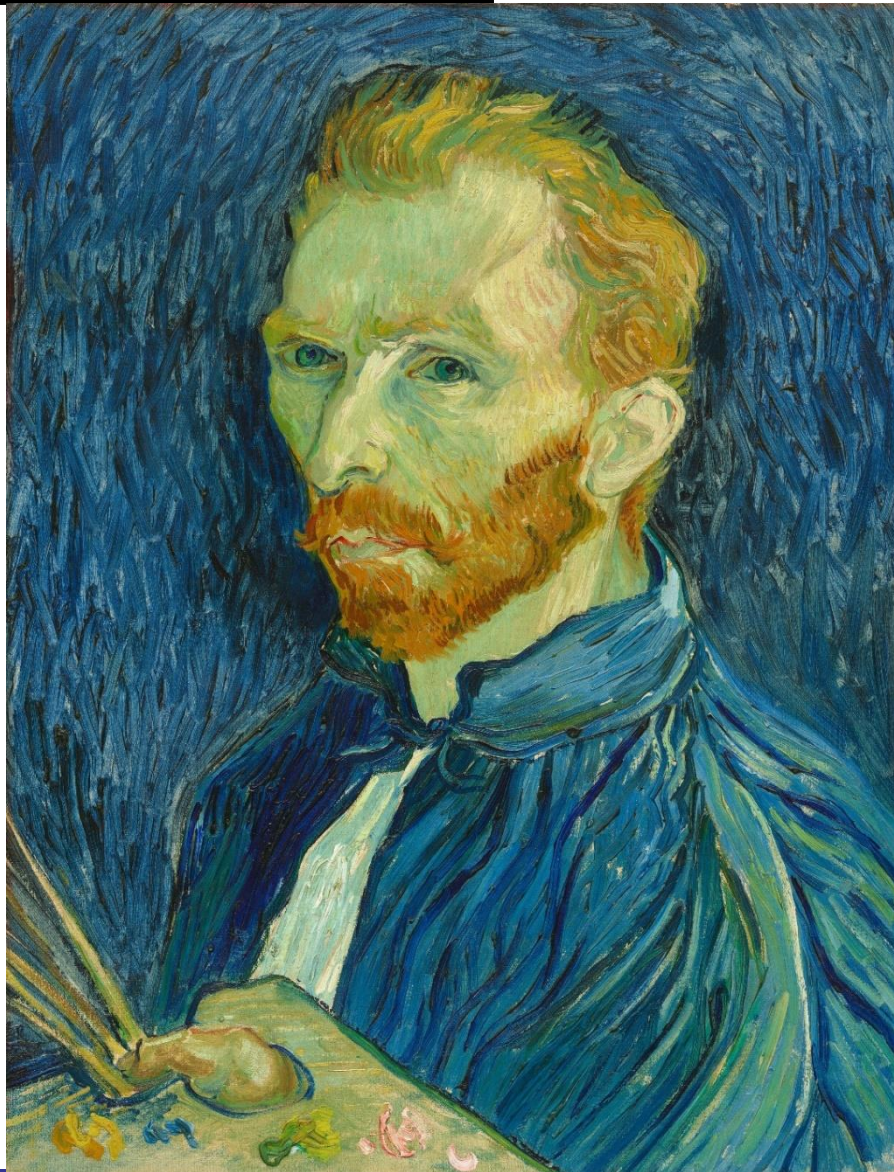

PRODUCT BENEFITS OF USING CO₂ TECHNOLOGY



VIBRANT
COLOURS

LOWER
OPERATIONAL
COSTS

BETTER
COLOUR &
LIGHT
FASTNESS

EASY
COLOUR
CORRECTION

SHORT
LEAD
TIMES

98%
COLOUR
CONSISTENCY

Polyester

Knit



Woven

- Advised CFM >25



Poly Cotton

- Only PET is dyed



Poly Spandex

- RC in water required
- Only light shades <5% spandex



Micro Fibre

- RC in water required



Under development

- Nylon & Nylon Spandex
- Poly Spandex
- Mirco Fibre

THE NEW STATE OF THE ART DYEING 4

DyeCoo®

INDUSTRY
4.0

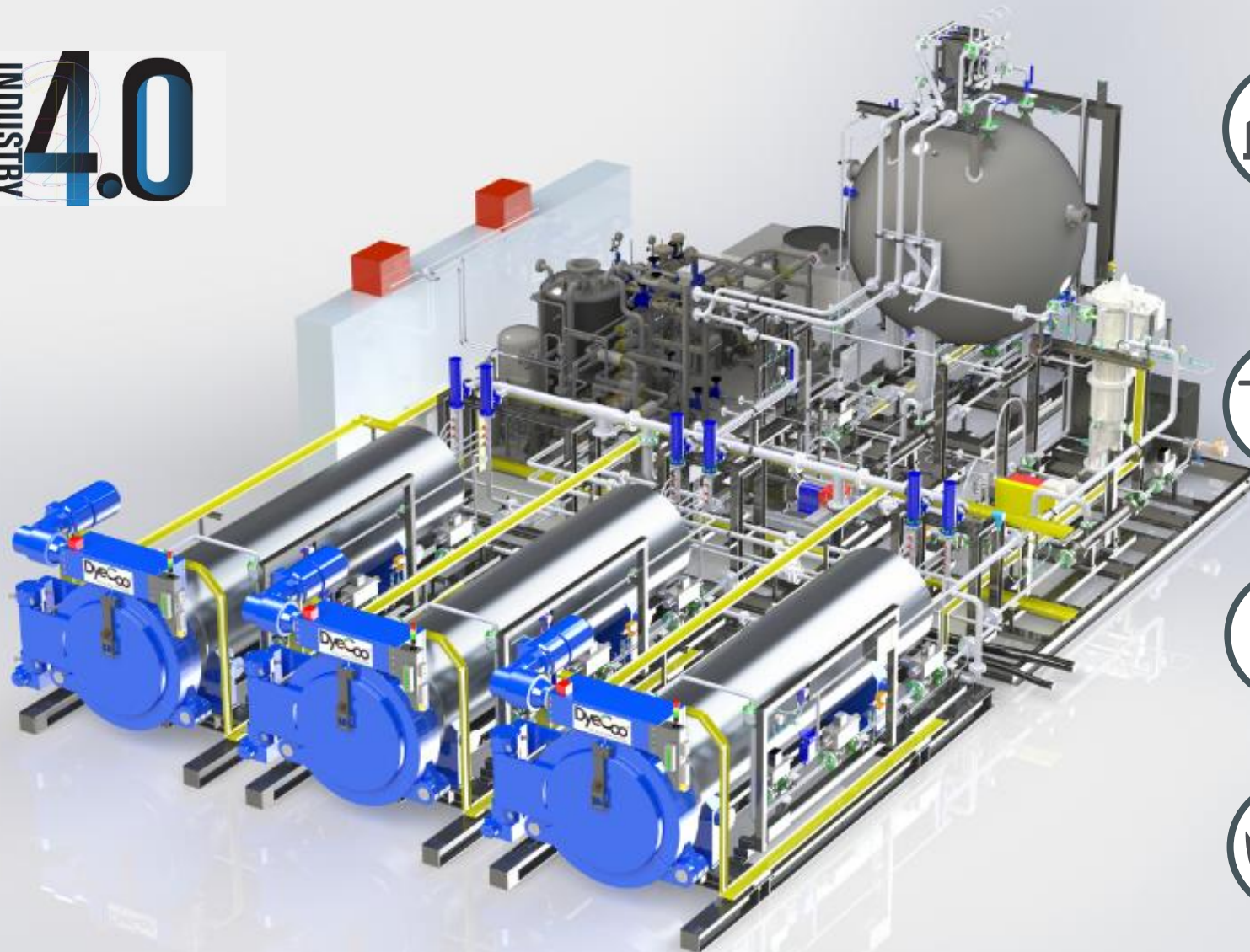

3 DYEING VESSELS
DYEING UP TO 4 TON PER DAY
AVG. 24 BATCHES/DAY
MAX 200KG PER BATCH



FOR 100% POLYESTER
WOVEN, KNIT, YARN & FIBRE
MAXIMUM FABRIC WIDTH 200CM



100% WATER FREE
NO REDUCTION CLEARING



95% RECYCLING OF CO2
FREE OF PROCESS CHEMICALS
LESS ENERGY

THE DYEON AND ITS AUXILIARY EQUIPMENT...

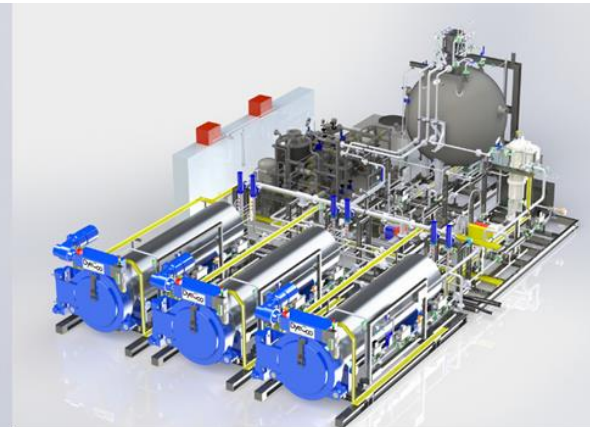
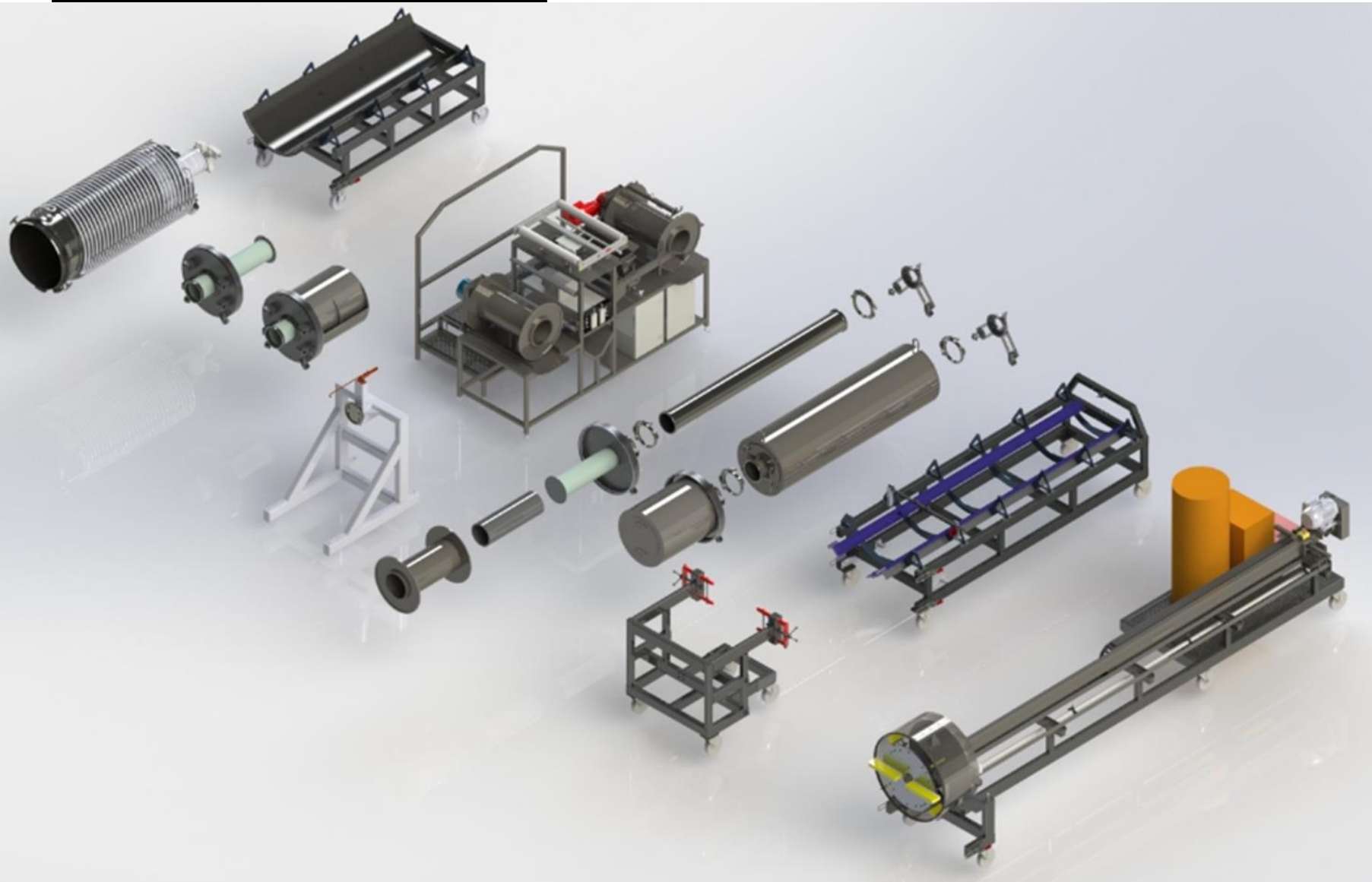

SAFETY IS NEVER AT RISK...



NO ACCIDENTS SINCE THE START IN 2010



Software prevents
operating errors

Independent safety
computer



Designed according
to ASME standard.
(Design regulation for
pressure vessels)



Certified by Veritas
and national
certifying authority



CO₂ detection
system, safety
valves and
emergency stops.

PROCESS FLOW FOR CO₂ DYEING IN AN INDUSTRIAL GLANCE



**DYE POWDER
HANDLING**



**DYE
PREPARATION**

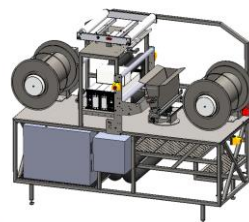

**LOADING
FABRIC &
CONNECT
DYE HOLDER**

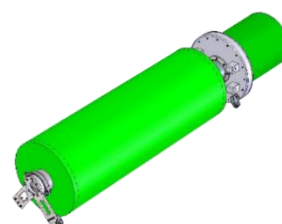

CO₂ DYEING



HANDLING



FABRIC



BEAM WINDING



Dye Process Flow

PRINCIPLES OF CO₂ DYEING: THE PROCESS

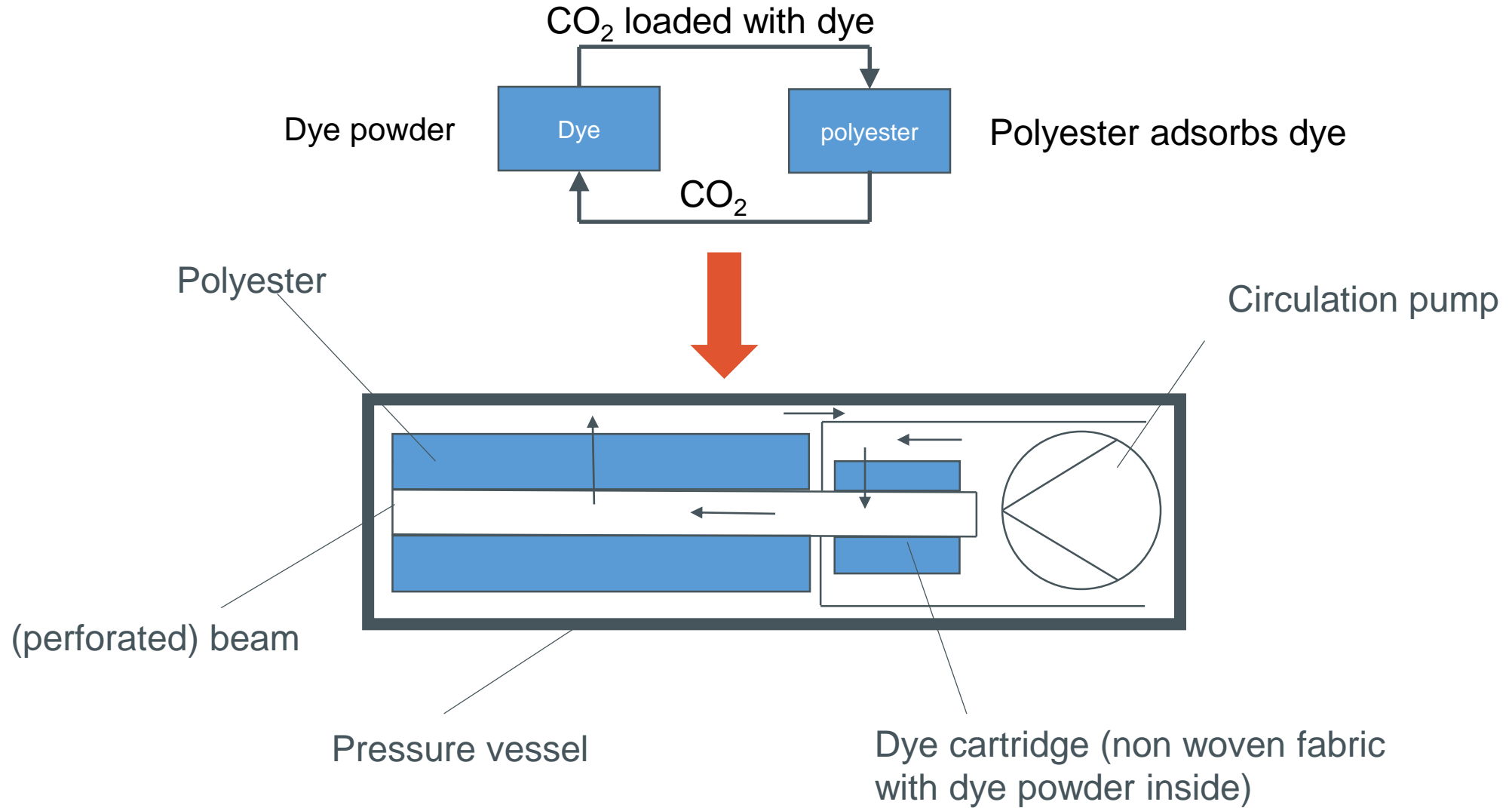

CO₂ IS RECYCLED AFTER EACH BATCH

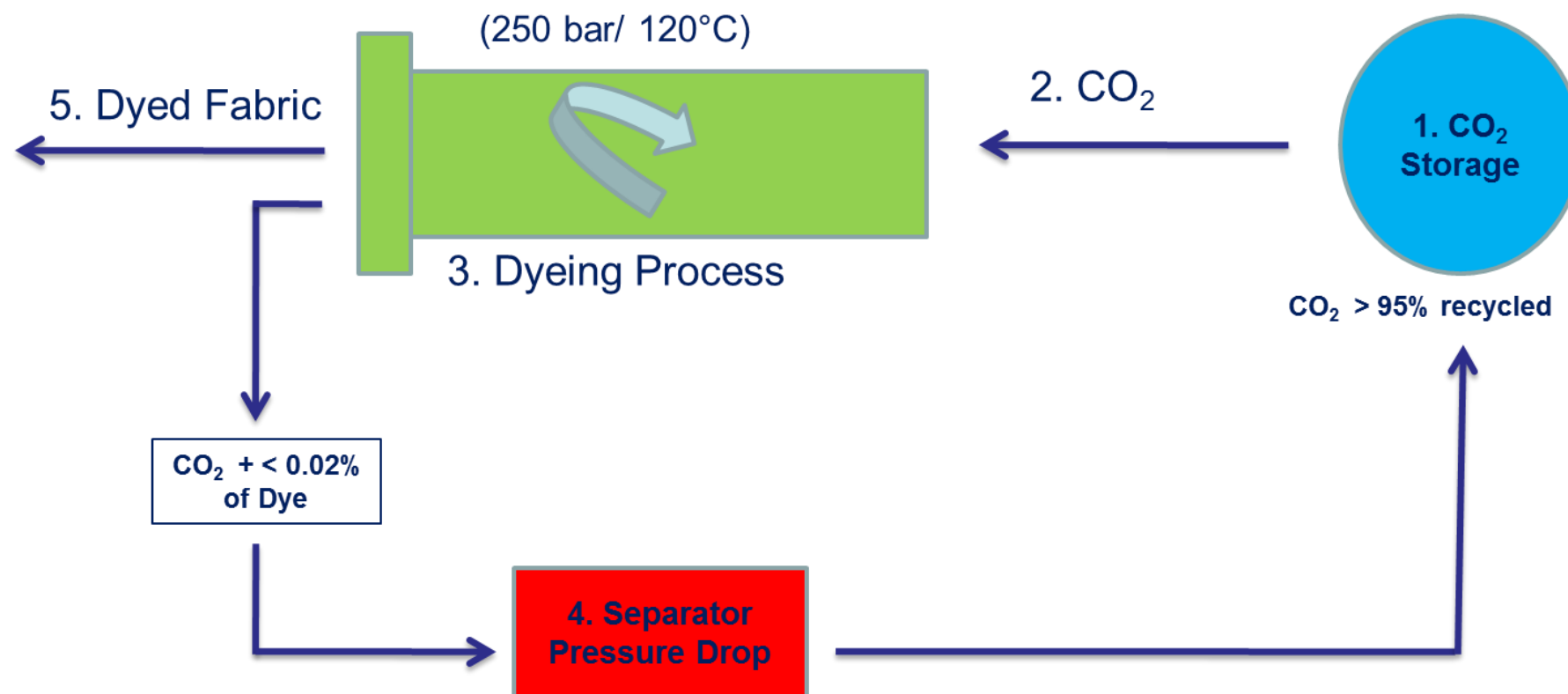

3 VESSEL DYE MACHINE

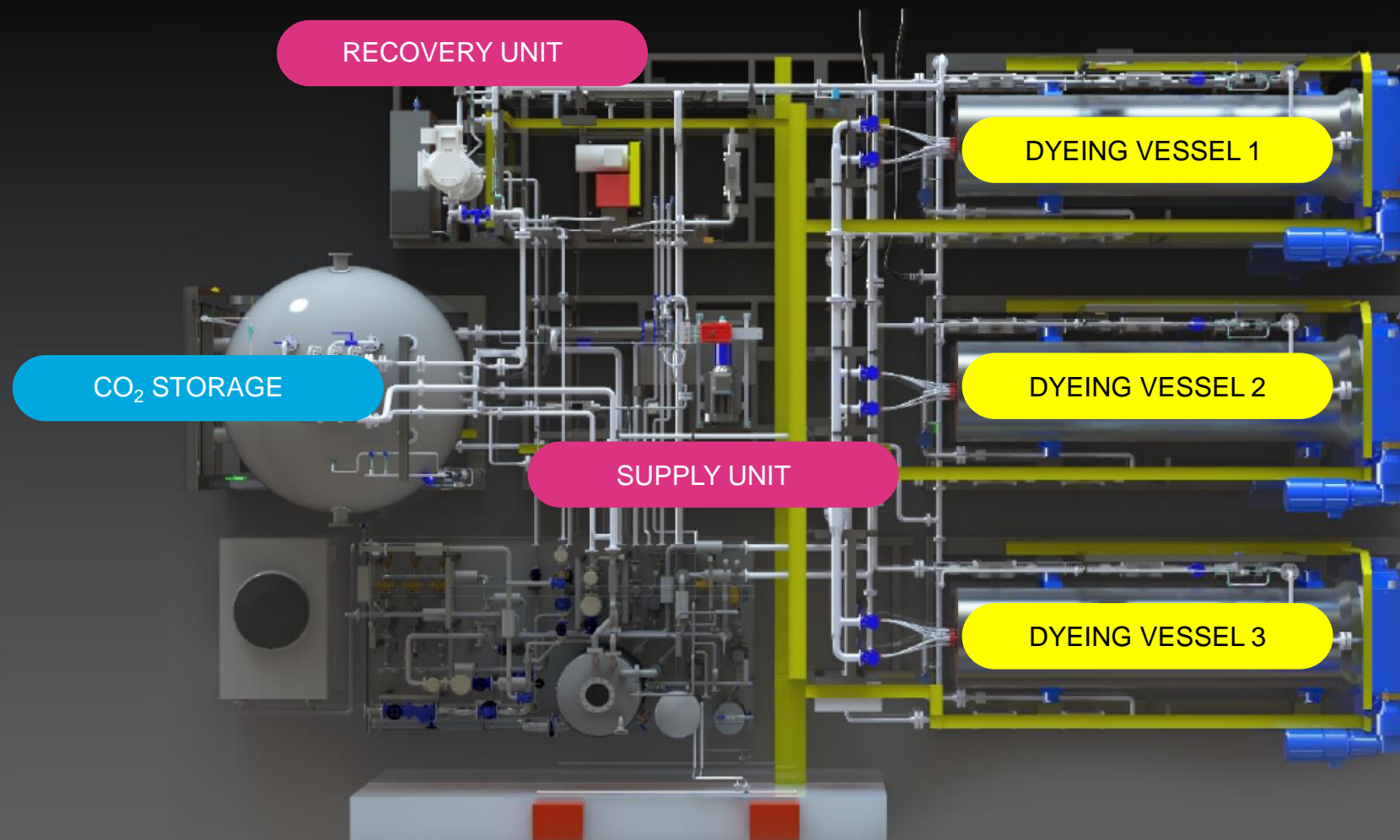

PROCESS FLOW FOR CO₂ DYEING IN AN INDUSTRIAL GLANCE

DYE POWDER
HANDLING



DYE
PREPARATION

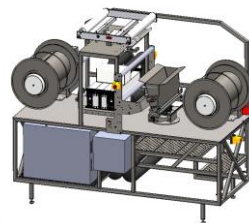

LOADING
FABRIC &
CONNECT
DYE HOLDER

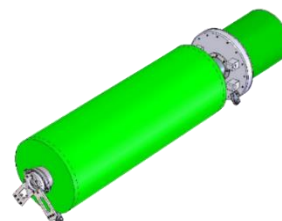

CO₂ DYEING



HANDLING



FABRIC



BEAM WINDING



HOW TO PREPARE A DYE CARTRIDGE

Dye powder
handling

1

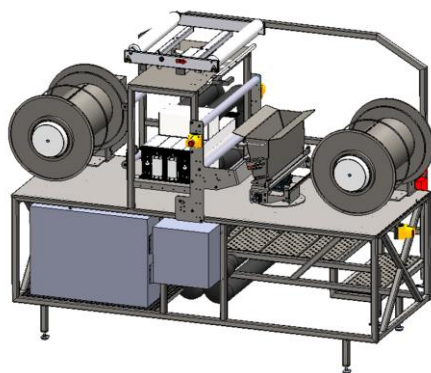

handling

2

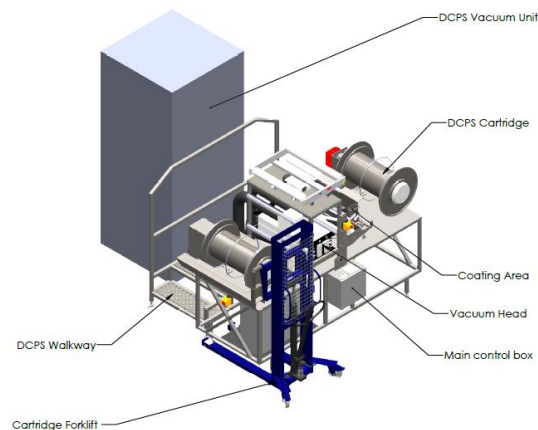

handling

3

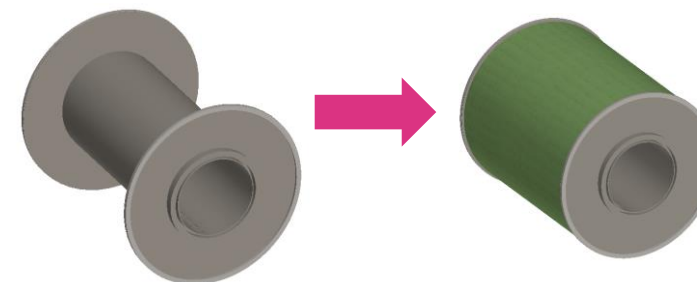

FABRIC BEAM PREPARATION PROCESS

1

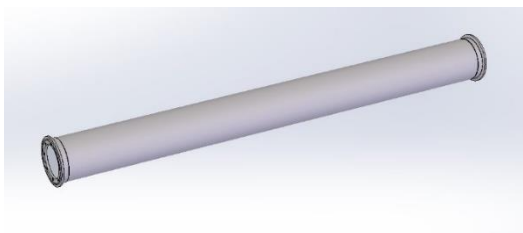

2

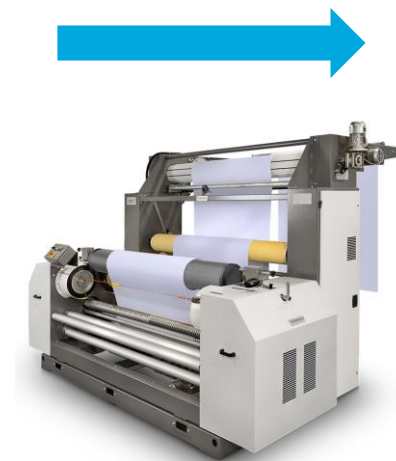

Bianco Soft Winder

3

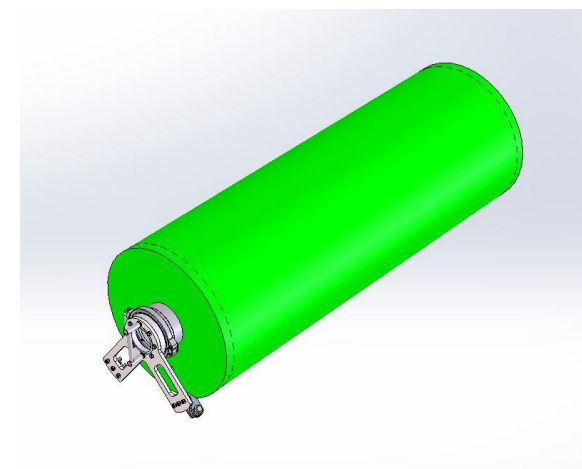
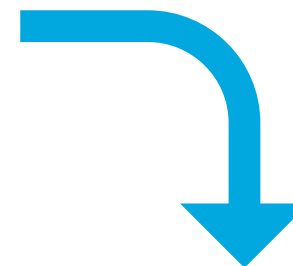

PREPARING THE INTERNAL ASSEMBLY

1



+ =

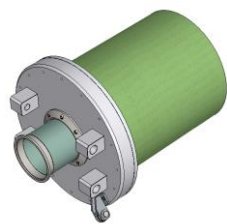

+



3

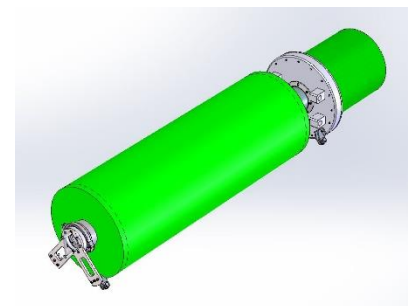

Internal: ready for loading
into DyeOx machine



4

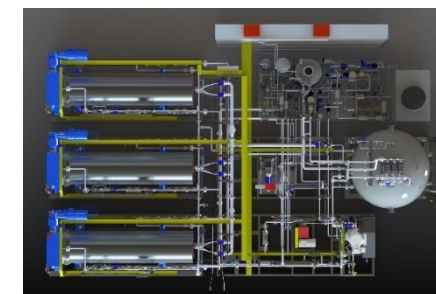

Dyeing step

VESSEL: DYE AND TEXTILE INTRODUCTION

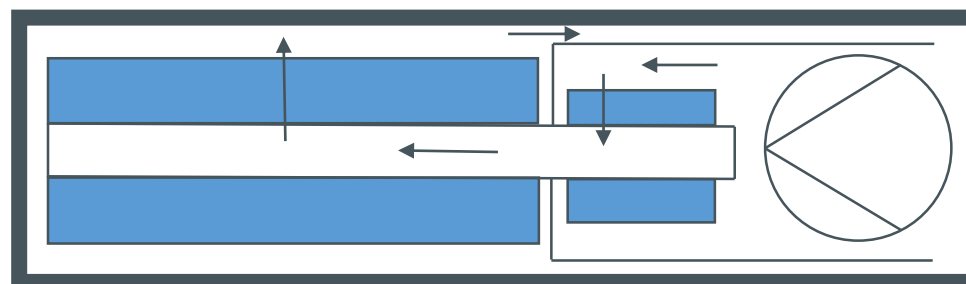

Bianco Machinery for CO₂ dyeing

THE BIANCO BEAM WINDER AS A PIVOTAL TOOL FOR CO2 DYEING



- › Tension control is critical for beam dyeing
 - › Fabric shifting
 - › Moire effects
 - › Flow control
 - › Level dyeing
- › Bianco developed an optimized version of the Bianco Soft Winder for CO2 dyeing
- › DyeCoo customers chose for quality and hence for Bianco beam winding

THE CLEANDYE CO2 FACTORY IN VIETNAM – USING BIANCO MACHINERY



- Green field development in Vietnam
- Max cap 6 DyeCoo machines
- Operational 2018



CleanDye

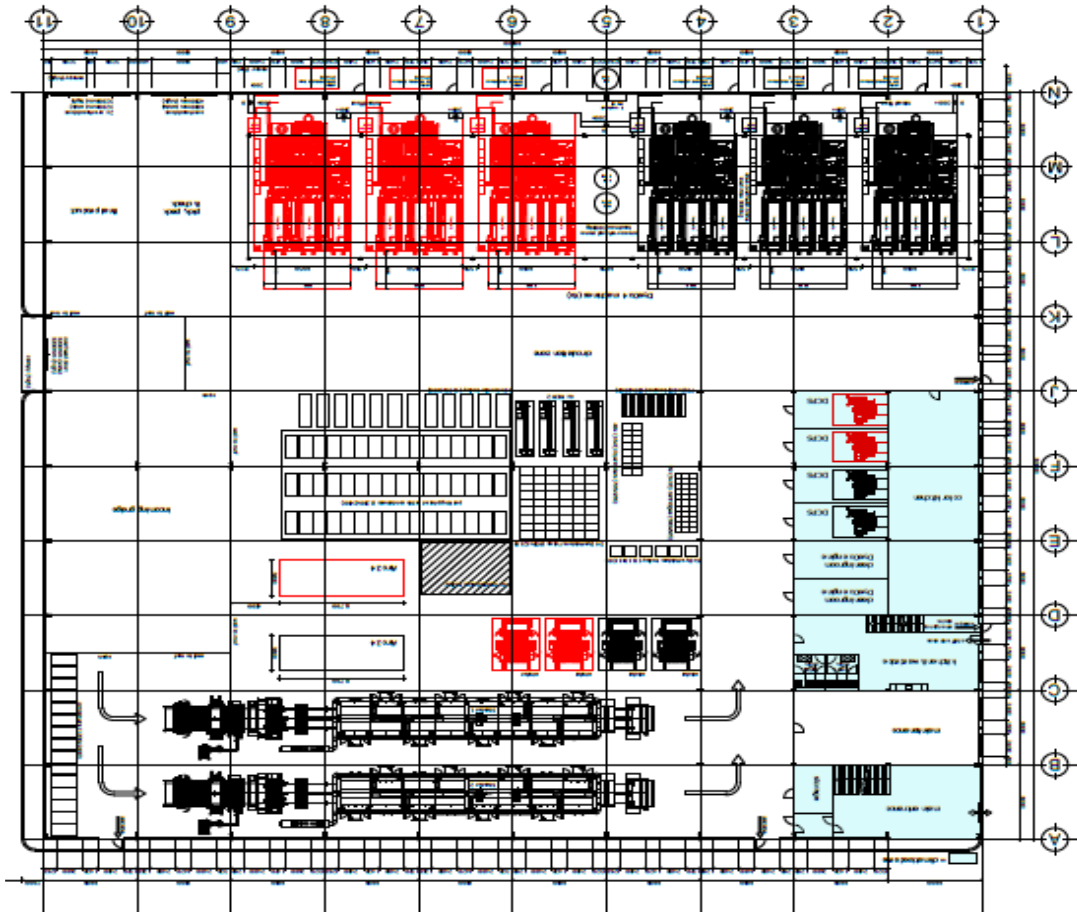

Bianco Soft Winder

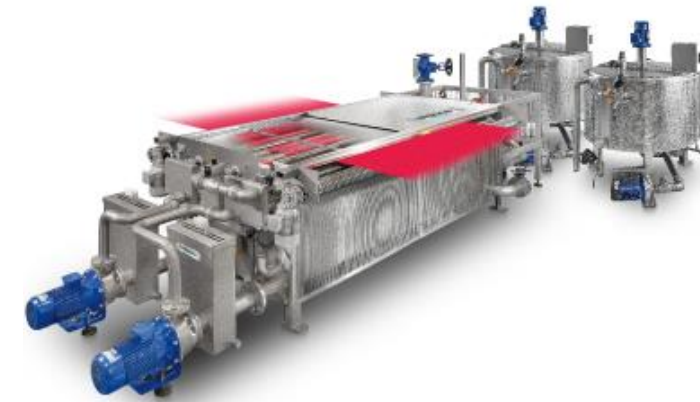

Happy Scour Tank

CO2 Dye development

BUILDING YOUR COLOUR GAMUT WITH OUR DYESTUFF PARTNERS...



- Pure dyes are used, no dispersing agents and other additives
- “Same” dyes are used, giving the same or better quality product
- Polyester dyes for CO₂ dyeing are commercially available

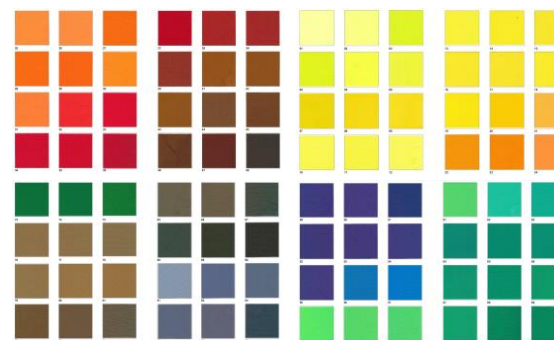

DYESTUFF IS
AVAILABLE FOR YOUR
POLYESTER PRODUCTS
.... NOW AND IN THE
FUTURE

LAB DYE EQUIPMENT FOR CO₂ DYEING

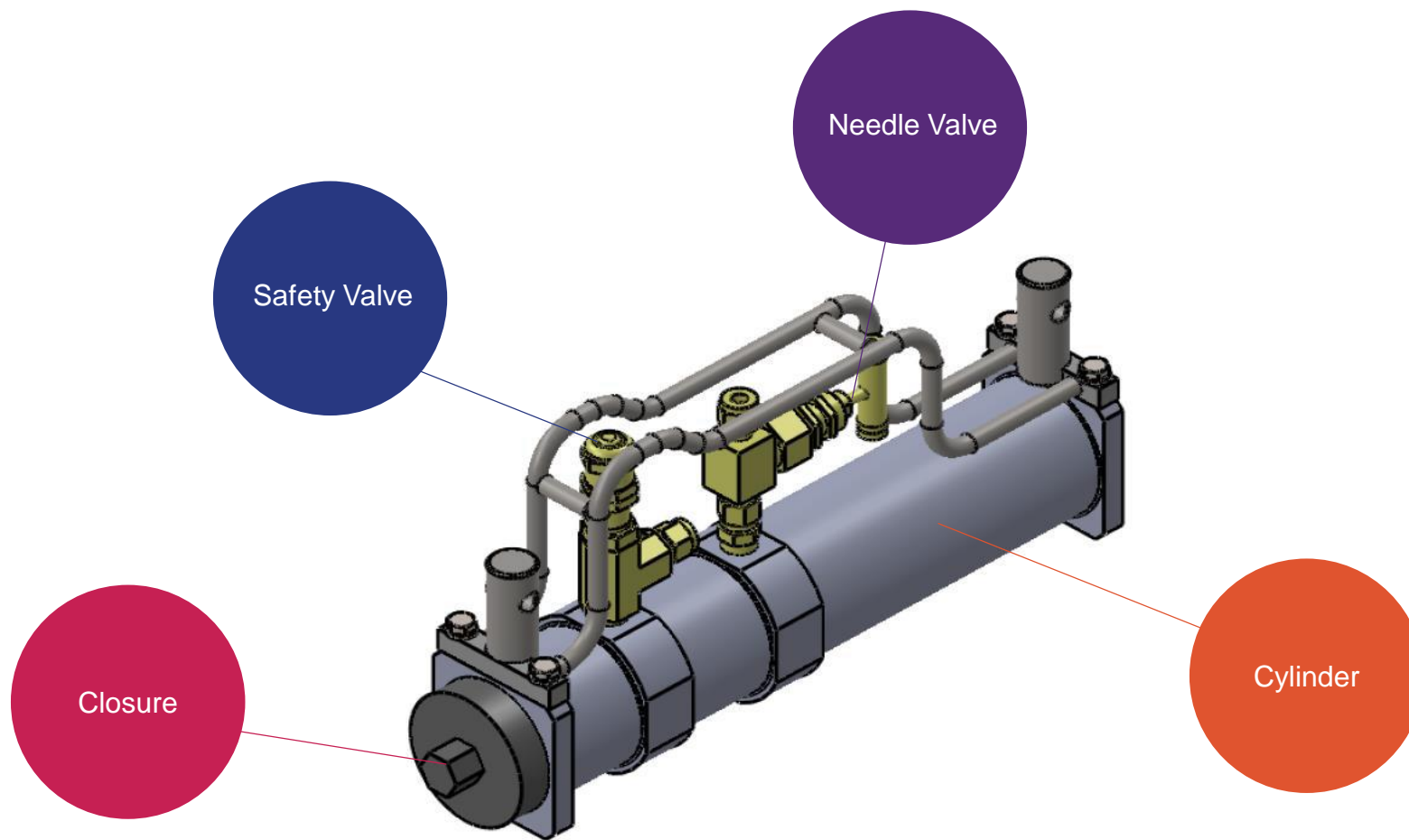

Size app.: 40 cm

Innovation Roadmap

INNOVATION ROADMAP FOR FUTURE APPLICATIONS..

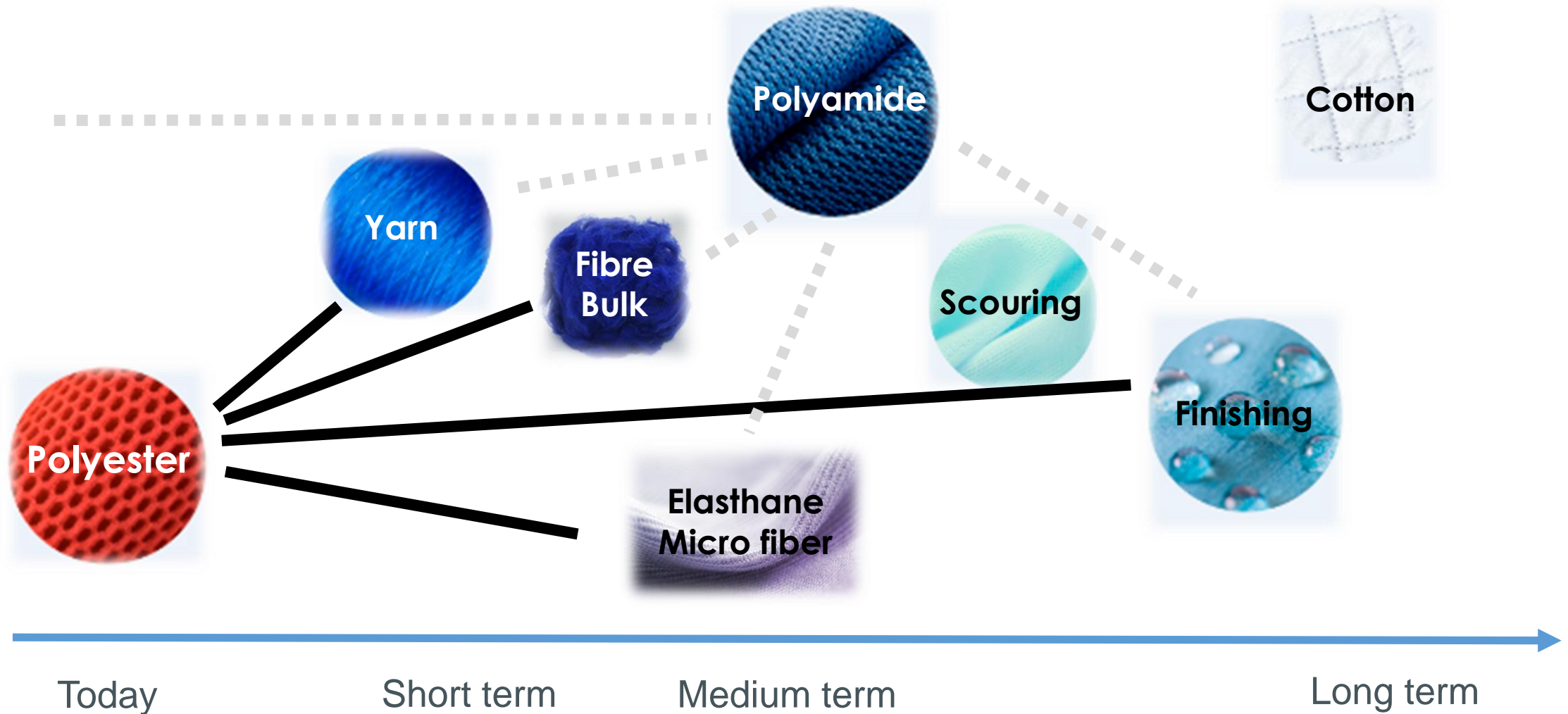

OUR VISION – "THE DYE HOUSE OF THE FUTURE"



**CHANGING THE WORLD OF TEXTILES
FOR EVER...**

